

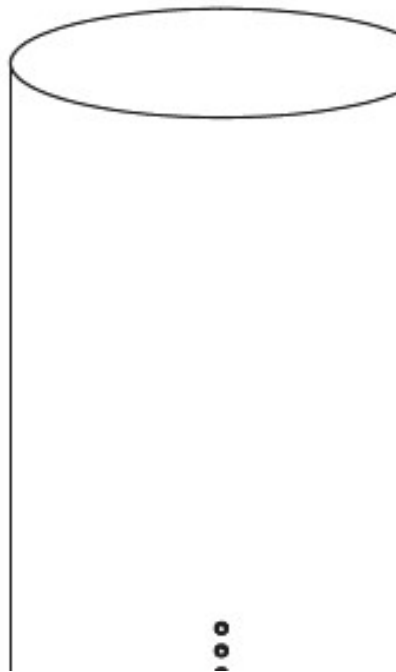

Cooker Hood Instruction Manual



Content

1.....	Safety instructions
2.....	Installation
3.....	Start using your cooker hood
4.....	Troubleshooting
5.....	Maintenance and cleaning
6.....	Environment protection

SAFETY INSTRUCTIONS

This manual explains the proper installation and use of your cooker hood, please read it carefully before using even if you are familiar with the product.

The manual should be kept in a safe place for future reference.

Never to do:

- Do not try to use the cooker hood without the grease filters or if the filters are excessively greasy!
- Do not install above a cooker with a high level grill.
- Do not leave frying pans unattended during use because overheated fats or oils might catch fire.
- Never leave naked flames under the cooker hood.



- If the cooker hood is damaged, do not attempt to use.
- Do not flambé under the cooker hood.
- CAUTION: Accessible parts may become hot when used with cooking appliances.
- The minimum distance between the supporting surface for the cooking vessels on the hob and the lowest part of the cooker hood. (When the cooker hood is located above a gas appliance, this distance shall be at least 65 cm)
- The air must not be discharged into a flue that is used for exhausting fumes from appliances burning gas or other fuels. Cooker hoods and other cooking fume extractors may adversely affect the safe operation of appliances burning gas or other fuels (including those in other rooms) due to back flow of combustion gases. These gases can potentially result in carbon monoxide poisoning. After installation

of a cooker hood or other cooking fume extractor, the operation of open flued gas appliances should be tested by a competent person to ensure that back flow of combustion gases does not occur.



Always to do:

- Important! Always switch off the electricity supply at the mains during installation and maintenance such as light bulb replacement.
- The cooker hood must be installed in accordance with the installation instructions and all measurements followed.
- All installation work must be carried out by a competent person or qualified electrician.
- Please dispose of the packing material carefully. Children are vulnerable to it.
- Pay attention to the sharp edges inside the cooker hood especially during installation and cleaning.
- Make sure the ducting has no bends sharper than 90 degrees as this will reduce the efficiency of the cooker hood.
- Warning: Failure to install the screws or fixing device in accordance with these instructions may result in electrical hazards
- Warning: Before obtaining access to terminals, all supply circuits must be disconnected.

- If the voltage rating of the lamp is less than the rated voltage of the appliance, the voltage rating of the lamp shall also be marked on or near the lamp holder.

Always to do:

- Always put lids on pots and pans when cooking on a gas cooker.
- When in extraction mode, air in the room is being removed by the cooker hood. Please make sure that proper ventilation measures are being observed. The cooker hood removes odours from room but not steam.
- Cooker hood is for domestic use only.



- If the supply cord is damaged, it must be replaced by the manufacturer, its service agent or similarly qualified persons in order to avoid a hazard.
- This appliance is not intended for use by persons (including children) with reduced physical, sensory or mental capabilities, or lack of experience and knowledge, unless they have been given supervision or instruction concerning use of the appliance by a person responsible for their safety
- Children should be supervised to ensure that they do not play with the appliance.
- This appliance can be used by children aged from 8 years and above and persons with reduced physical, sensory or mental capabilities or lack of experience and knowledge if they have been given supervision or instruction concerning use of the appliance in a safe way and understand the hazards involved. Children shall not play with the appliance. Cleaning and user

maintenance shall not be made by children without supervision.



Always to do:

- **Caution:** The appliance and its accessible parts can become hot during operation. Be careful to avoid touching the heating elements. Children younger than 8 years old should stay away unless they are under permanent supervision.
- There shall be adequate ventilation of the room when the cooker hood is used at the same time as appliances burning gas or other fuels.
- There is a fire risk if cleaning is not carried out in accordance with the instructions
- Regulations concerning the discharge of air have to be fulfilled.
- Clean your appliance periodically by following the method given in the chapter MAINTENANCE.
- For safety reason, please use only the same size of fixing or mounting screw which are recommended in this instruction manual.
- Regarding the details about the method and frequency of cleaning, please refer to maintenance and cleaning section in the instruction manual.
- Regarding the information about how the appliance is to be fixed to its support, please refer to Operation section, the Installation procedures in this manual.
- Cleaning and user maintenance shall not be made by children without supervision.
- When the cooker hood and appliances supplied with energy other

than electricity are simultaneously in operation, the negative pressure in the room must not exceed 4 Pa (4×10^{-5} bar).

- **WARNING:** Danger of fire: do not store items on the cooking surfaces.

- A steam cleaner is not to be used.
- **NEVER** try to extinguish a fire with water, but switch off the appliance and then cover flame e.g. with a lid or a fire blanket.

INSTALLATION (VENT OUTSIDE)

MOUNTING OF THE V-FLAP

If the cooker hood does not have an assembled V-flap 1, you should mount the half-parts to its body.

To mount the V-flap 1 you should:

- Mount two half-parts 2 into the body 6
- the pin 3 should be top oriented;
- the axis 4 should be inserted in the holes 5 on body;
- repeat all the operations for the 2nd half-part

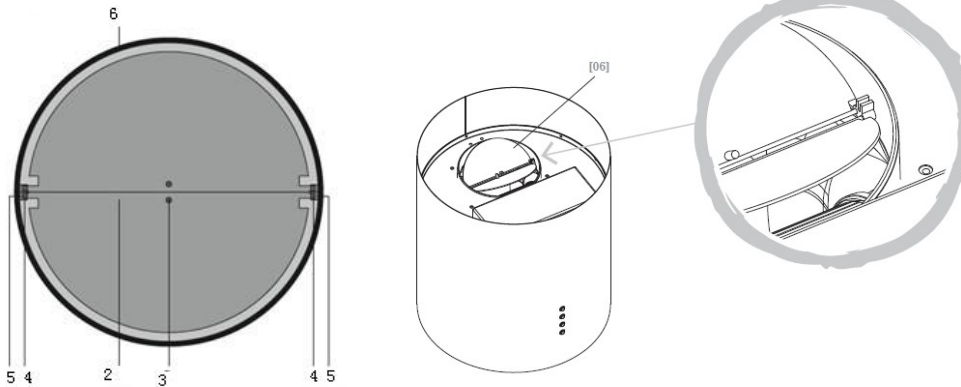
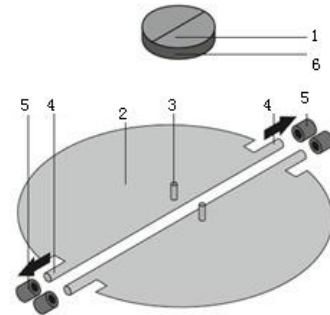

INSTALLATION

If you have an outlet to the outside, your cooker hood can be connected as below picture by means of an extraction duct. (enamel, aluminum, flexible pipe or non-flammable material with an interior diameter of 150mm)

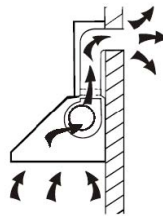

1. Before installation, turn the unit off and unplug it from the outlet.



2. The cooker hoods should be placed at a distance of 65-75cm from the cooking surface for best effect. See Pic 1

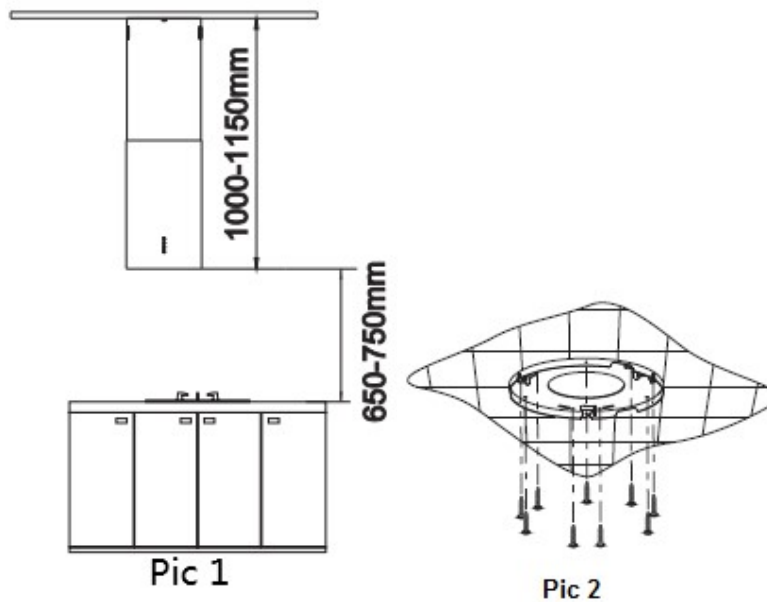

3. For safety, the ceiling should be bear at least 120kg, and the thickness should be more than 30mm. Drill a hole on the position for cooker hood with $\Phi 170\text{mm}$ on the ceiling.
4. According to the hanging board, drill 9 holes on the ceiling. Use 9pcs ST6X40mm screws to fix the hanging board on the wooden ceiling or use 6pcs explode screw to fix the hanging board on concrete ceiling. See pic 2.
5. Calculate the length of angle iron according to Pic 1. To connect the angle iron and bracket with 18pcs M4X10 screws, M4 nut and washer. (the overlap between angle iron should more than 100mm) See pic 3.
6. Using 6pcs M4X10 screws to fix the angle iron on the cooker hood housing, and install the expansion pipe. See pic 4/5. Set the inside chimney.

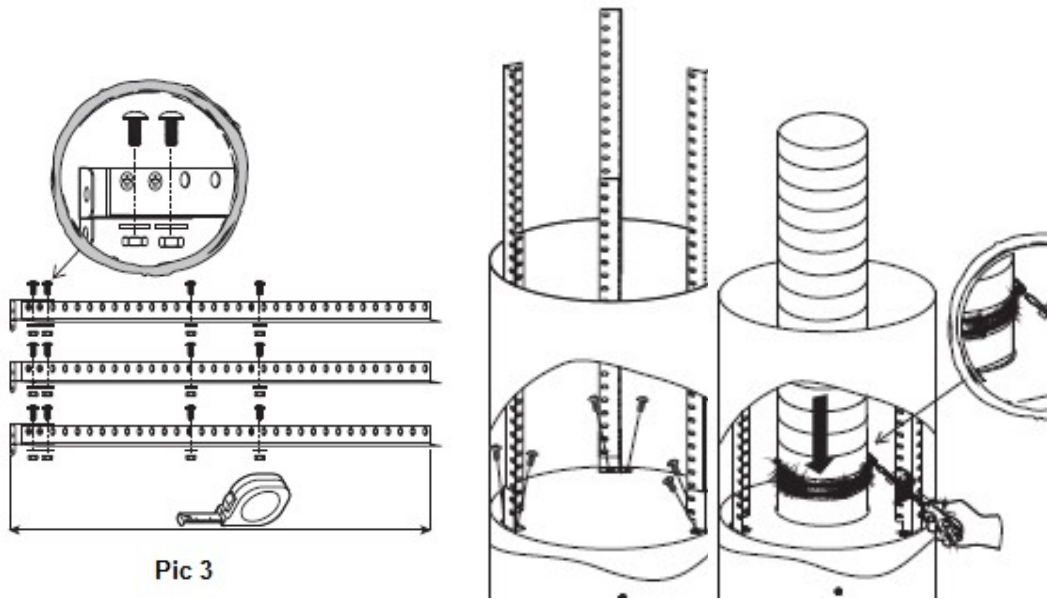

7. Put fixation of angle iron on the three installed angle iron. And then using 6pcs M4X10 screws, M4 nuts and washers to fix. See pic 6.

8. Put the inside chimney on the cooker hood housing. See pic 7

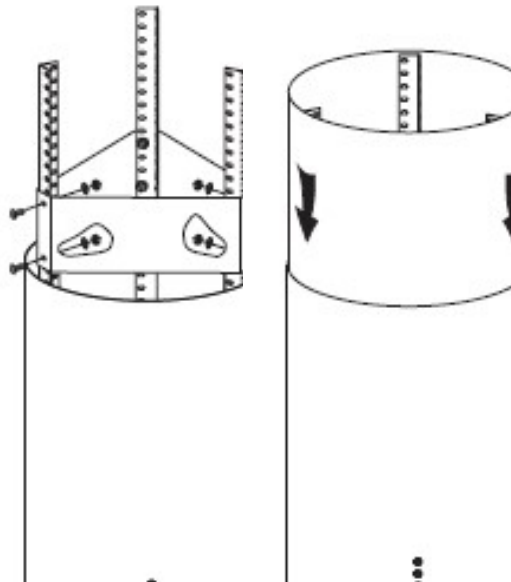

9. Put up the unit, and take the expansion pipe out of ceiling. And then using 6pcs M4X10 screws, M4 nut and washer fix the angle iron of unit to the hanging board. See pic 8

10. Undrawn the inside chimney and use 3pcs ST4X8 screws to fix the inside chimney on hanging board. See pic 9.

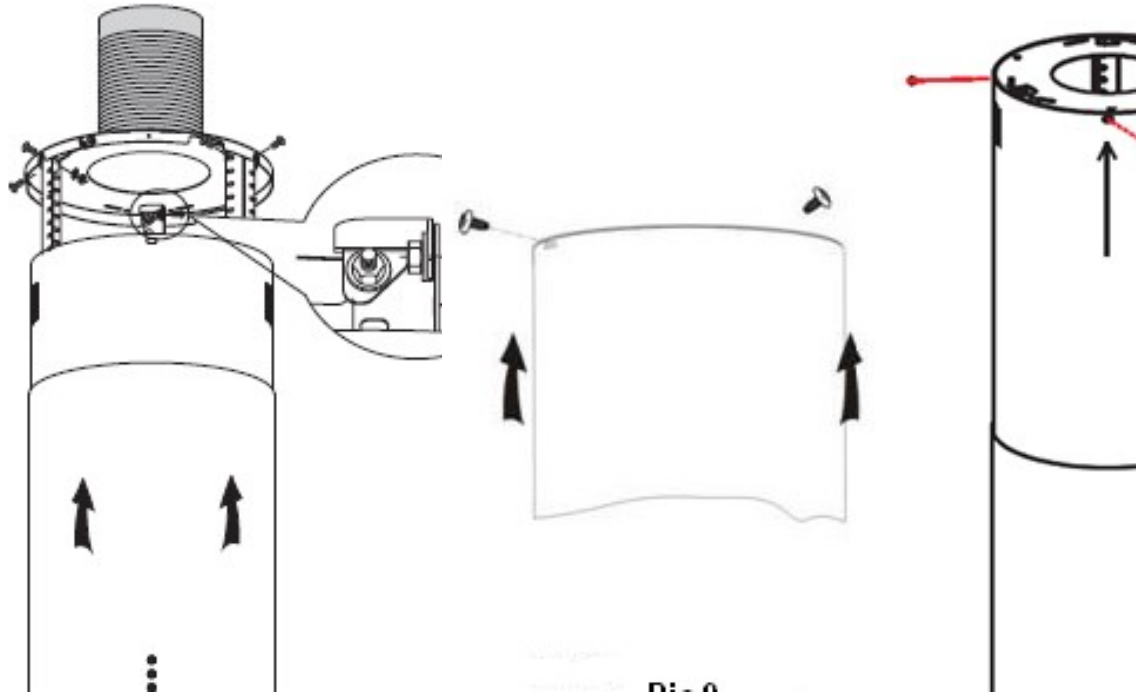

HINTS FOR EXHAUST DUCT INSTALLATION

The following rules must be strictly followed to obtain optimal air extraction:

- Keep expansion pipe short and straight.
- Do not reduce the size or restrict the expansion pipe.
- When using the expansion pipe always install the pipe pulled taut to minimize pressure loss.
- Failure to observe these basic instructions will reduce the performance and increase noise levels of the cooker hood.
- Any installation work must be carried out by a qualified electrician or competent person.
- Do not connect the ducting system of the hood to any existing ventilation system which is being used for any other appliance, such as warmer tube, gas tube, hot wind tube.
- The angle of the bend of the expansion pipe should not be less than 120°; you must direct the pipe horizontally, or, alternatively, the pipe should go up from the initial point and should be led to an outer wall.
- After the installation, make sure that the cooker hood is level to avoid grease collection at one end.
- Ensure the expansion pipe selected for installation complies with relevant standards and is fire retardant.

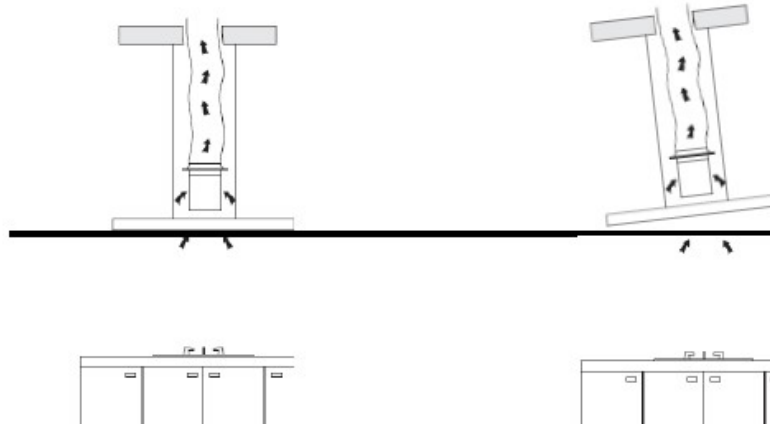





<p>WARNING:</p> 	<ul style="list-style-type: none"> ➤ For safety reason, please use only the same size of fixing or mounting screws which are recommended in this instruction manual. ➤ Failure to install the screws or fixing device in accordance with these instructions may result in electrical hazards.
--	---



Start Using Your Cooker Hood

Electronic button







There are five buttons:  (Low),  (Mid),  (High),  (Lamp),  (Power). See picture above.













1. After connecting to power, indicator light will lit on, all the output close and the hood will enter standby mode. The indicator light will be off automatically after reminding if no operation.

2. Power on: Press power button  once, its indicator light will lit on, the hood works at low speed. Indicator light of low speed  will be bright. Press power button again to close it, and its indicator light will be off. All the function operation of the hood will be closed, the hood enters into standby mode, and run by circle.

The speed buttons and lamp button can work separately and not controlled by the power button. When a certain function button is pressed, the hood operates at that function status. Press (Power) button under any status, the cooker hood will be switched off without any functions.

3. Press lamp button  once; lights will be turn on. Indicator light of lamp button  and power button  will lit on. Press lamp button  again to turn off

the lights. Indicator light of lamp button  and power button  will be off. And recycle like this.

4. Press the  (High) button once, motor runs on high speed, the indicator light of high button  and power button  will beam. Press high button  again and the motor will stop. Indicator light of high button and power button will be off, and run by circle.
5. Press the  (Mid) button once, motor runs on middle speed, the indicator light of middle button  and power button  will beam. Press middle button  again and the motor will stop. Indicator light of middle button and power button will be off, and run by circle.
6. Press the  (low) button once, motor runs on low speed, the indicator light of low button  and power button  will beam. Press low button  again and the motor will stop. Indicator light of low button and power button will be off, and run by circle.
7. Low speed, mid speed and high speed cannot work at the same time. When hood is on high speed, press low speed, it will turn to low speed at once; when it is in low speed, press middle speed, it will turn to middle speed immediately, and so on.

TROUBLESHOOTING

Fault	Possible Cause	Solution
Light on, but motor does not work	Fan switch turned off	Select a fan switch position.
	Fan switch failed	Contact service center.
	Motor failed	Contact service center.
Light does not work, motor does not work	House fuses blown	Reset/Replace fuses.
	Mains power cable is loose or disconnected	Refit mains power cable to power outlet. Switch power outlet on.
Oil leakage	One way valve and the outlet are not tightly sealed	Take down the one way valve and seal with sealant.
	Leakage from the connection of chimney and cover	Take chimney down and seal.
Lights not working	Broken or faulty bulbs	Replace bulbs as per this instruction.
Insufficient suction	The distance between the cooker hood and the gas top is too far	Refit the cooker hood to the correct distance.
The Cooker hood inclines	The fixing screw is not tight enough	Tighten the hanging screw and make it horizontal.

NOTE:
 Any electrical repairs to this appliance must conform to your local, state and federal laws. Please contact the service centre if in any doubt before undertaking any of the above. Always disconnect the unit from the power source when opening the unit.

MAINTENANCE AND CLEANING

Caution:

- Before maintenance or cleaning is carried out, the cooker hood should be disconnected from the mains power supply. Ensure that the cooker hood is switched off at the wall socket and the plug removed.
- External surfaces are susceptible to scratches and abrasions, so please follow the cleaning instructions to ensure the best possible result is achieved without damage.



GENERAL

Cleaning and maintenance should be carried out with the appliance cold especially when cleaning. Avoid leaving alkaline or acid substances (lemon juice, vinegar etc.) on the surfaces.

STAINLESS STEEL

The stainless steel must be cleaned regularly (e.g. weekly) to ensure a long life expectancy. Dry with a clean soft cloth. A specialized stainless steel cleaning fluid may be used.

NOTE:

Ensure that wiping is done along with the grain of the stainless steel to prevent any unsightly crisscross scratching patterns from appearing.

CONTROL PANEL SURFACE

The inlay control panel can be cleaned using warm soapy water. Ensure the cloth is clean and well wrung before cleaning. Use a dry soft cloth to remove any excess moisture left after cleaning.

Important

Using neutral detergents and avoid using harsh cleaning chemicals, strong household detergents or products containing abrasives, as this will affect the appearance of the appliance and potentially remove any printing of artwork on the control panel and will void manufactures warrantee.

GREASE MESH FILTERS

The mesh filters can be cleaned by hand. Soak them for about 3 minutes in water with a mild detergent and brush it gently with a soft brush. Please do not apply too much pressure so as to avoid any damage it . (Leave to dry naturally out of direct sun light)

Filters should be washed separately to crockery and kitchen utensils. It is advisable not to use rinse aid.

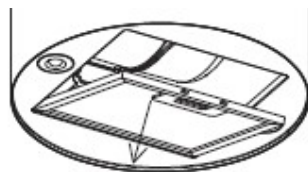

INSTALLING GREASE MESH FILTERS

- To install filters for the following four steps:
 - Angle the filter into the slots at the back of the hood.
 - Push the button on the handle of the filter.
 - Release the handle once the filter fits into a resting position.
 - Repeat to install all filters.

CARBON FILTER

Activated carbon filter can be used to trap odors. Normally the activated carbon filter should be changed every 3 to 6 months according to your cooking habits. The installation procedure of activated carbon filter is as below:

- 1) Remove the filters.
- 2) The carbon filters are located at either end of the motor. Turn the charcoal filters anti-clockwise until they are unscrewed.
- 3) Apply reverse procedure to install the charcoal filter

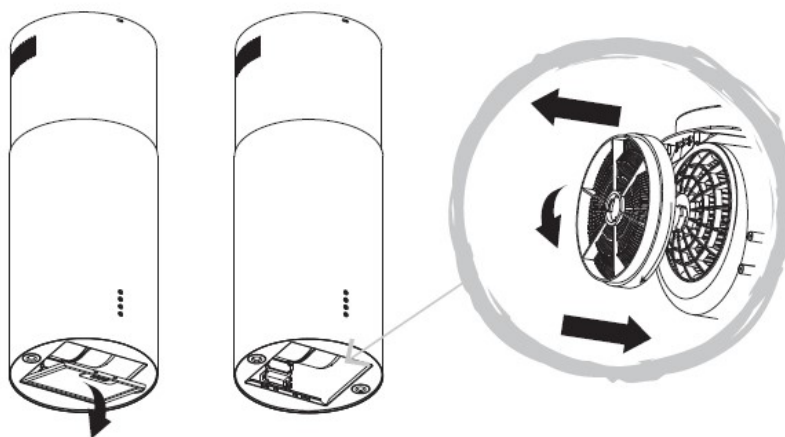

NOTE:

- Make sure the filter is securely locked. Otherwise, it would loosen and cause danger.
- When activated carbon filter attached, the suction power will be lowered.

BULB REPLACEMENT

<p>Important :</p> 	<ul style="list-style-type: none">✧ The bulb must be replaced by the manufacturer, its service agent or similarly qualified persons.✧ Always switch off the electricity supply before carrying out any operations on the appliance. When handling bulb, make sure it has completely cooled down before any direct contact with hands.✧ When handling bulbs hold with a cloth or gloves to ensure perspiration does not come in contact with the bulb as this can reduce the life of the bulb.
--	---

Note:

- Before changing the lights, make sure that the appliance is turned off and unplugged.
- Protect against danger when changing lights, such as wearing gloves.

Changing the lights

- Remove the grease filter.
 - Use a tool or the hand to press the spring splinter of both sides of LED light to the inside, until the light is pressed out. Then slightly pull the light connecting wire out, and dismantle the terminal of the light connecting wire.
 - Apply the reverse procedure to install the light back.
- ILCOS D code for this lamp is: **DSR-1-S-41**
 - LED modules –round glass lamp
 - Max wattage: 2×1 W
 - Voltage range: DC 12V
 - Dimensions:

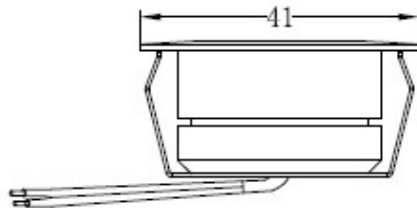

ENVIRONMENTAL PROTECTION:

	<p>This product is marked with the symbol on the selective sorting of waste electronic equipment. This means that this product must not be disposed of with household waste but must be supported by a system of selective collection in accordance with Directive 2012/19/EU. It will then be recycled or dismantled to minimize impacts on the environment, electrical and electronic products are potentially dangerous for the environment and human health due to the presence of hazardous substances. For more information, please contact your local or regional authorities.</p>
---	---

NOTE:

The following shows how to reduce total environmental impact (e.g. energy use) of the cooking process).

- (1) Install the cooker hood in a proper place where there is efficient ventilation.
- (2) Clean the cooker hood regularly so as not to block the airway.
- (3) Remember to switch off the cooker hood light after cooking.
- (4) Remember to switch off the cooker hood after cooking.

INFORMATION FOR DISMANTLING

Do not dismantle the appliance in a way which is not shown in the user manual. The appliance could not be dismantled by user. At the end of life, the appliance should not be disposed of with household waste. Check with your Local Authority or retainer for recycling advice.